

**COMMERCIAL & INDUSTRIAL HVAC EQUIPMENT**

**OPERATING AND SERVICE MANUAL**

**--DO NOT REMOVE FROM EQUIPMENT--**

**SERIAL NUMBER:**

For technical service or repair,

**FIRST CALL - INSTALLING CONTRACTOR:**

**SECOND CALL:**

**FINAL CALL:** Titan Air LLLP - (715) 597-2050

Please have serial number available when calling

**MANUFACTURED BY:**

Titan Air LLLP

13901 16th Street - P.O. Box 717

Osseo, WI 54758 - Phone 715-597-2050



## **WARNING**

Improper installation, adjustment, alteration, service or maintenance can cause property damage, injury or death. **READ** all maintenance instructions thoroughly before installing or servicing equipment.



## **CAUTION**

### **FOR YOUR SAFETY**

If you smell gas:

1. Open windows.
2. **DO NOT** touch electrical switches.
3. Extinguish any open flame.
4. Immediately call your gas supplier.

The use and storage of gasoline or other flammable vapors and liquids in open containers in the vicinity of this heater is **HAZARDOUS**.

## **NOTICE**

### **LOW TEMPRATURE LIMT**

If this heater is to be installed in an area of potential freeze up and a low temperature limit was not ordered, one should be installed to provide freeze protection in the event of a burner shut down.

## **NOTICE**

For outdoor equipment with a variable frequency drive (VFD) factory mounted in the unit, main power should remain on at all times especially during cold weather. Even if the unit will not run at night or over a weekend, main power should remain on to allow internal VFD self-heating which extends VFD service life.



## 24 MONTH WARRANTY

### 24 MONTH WARRANTY

Titan Air hereby warrants its products against defects in material and workmanship for a period of (24) twenty four months from date of shipment.

Start up checklist is due back within (30) thirty days of start-up or 120 days from date of delivery for 24 month warranty to be effective. After (30) thirty days, and up until (60) sixty days, a (13) thirteen month warranty will be observed. All warranties are null and void if start up checklist is not received within (60) sixty days from start-up or 120 days from date of delivery. NO EXCEPTIONS WILL BE MADE.

Titan Air reserves the right at Titan Air's option, to replace or repair free of charge, any part proven by Titan Air to be defective. Prompt notification of defective part must be given to Titan Air and defective part must be returned freight prepaid within (30) thirty days of notification.

WARRANTY INCLUDES ONLY PARTS SUPPLIED BY TITAN AIR INCIDENTAL COSTS AND LABOR CHARGES SHALL BE THE RESPONSIBILITY OF OTHERS. This warranty does not cover fuses, belts, filters, refrigerant or water damaged parts which are the result of improper storage or installation.

This warranty is void in event the product is improperly installed and/or operated under conditions other than normal published ratings, improperly maintained, misused or not in compliance with applicable codes or not in accordance with Titan Air's operating instructions.

This warranty is void if attempts to correct or repair any alleged defective part or parts are made by unauthorized personnel without Titan Air's written approval.

In no event shall Titan Air be held liable for any damage, incidental or consequential, arising from the installation, performance or operation of the product.

This warranty supersedes, voids, and/or is in lieu of any other verbal or written understanding which may not be in total accordance with this expressed warranty.

Warranted parts must be returned to Titan Air within 60 days to receive credit.

Purchased components such as Steam Generators Systems, Electric Coils, Refrigerant Condensers, Chillers, Coils, Heat Exchangers are covered under the original equipment manufacturer's warranty.



## 24 MONTH WARRANTY

### **PURPOSE/ APPLICABILITY**

This manual is intended to provide installation, operating and service information on Titan Air's Demand-Air™ variable air volume units.

A packet of reference materials for a specific unit (tracked by its Serial Number) is generally included with this Operating and Service Manual. The reference materials include Unit Specifications, Parts Lists, Gas Train and Burner Specifications, Electrical Schematic, and a Sequence of Operation. A start up checklist is also included in this packet. Review the reference materials for a specific unit and note any optional equipment or controls which are not specifically addressed in this manual prior to attempting start-up or service work.

The information and recommendations contained in this publication are based on general observation and are not intended to supplant requirements of federal, state or local codes having jurisdiction. These codes should be reviewed before installation of equipment. All units must be installed in accordance with national, state or local codes.

It is the responsibility of the purchaser at the time of order, to specify any and all code or insurance requirements that may dictate the addition of components to the equipment in order to comply with those requirements.

Only qualified personnel who have experience with the installation and operation of industrial/commercial direct fired equipment should attempt to service Titan Air equipment.



# TABLE OF CONTENTS

<u>GENERAL INFORMATION</u>	<u>PAGE #</u>		
24 MONTH WARRANTY .....	3	BLOWER WHEEL .....	30
PURPOSE/ APPLICABILITY .....	4	FLAME FAIL DIAGNOSTICS.....	31-32
EQUIPMENT ARRIVAL .....	6	GENERAL START-UP INFORMATION.	33
STORAGE.....	6	VALVE LEAK TEST .....	34
COMPONENTS.....	7-9	<b><u>SPECIFIC EQUIPMENT DETAILS</u></b>	
AIR FLOW SWITCH OPERATION .....	10	..... pages not numbered	
<b><u>INSTALLATION</u></b>		UNIT SPECIFICATION	
PRE-INSTALLATION .....	11	UNIT DRAWING	
POSITIONING THE HEATER.....	12	SEQUENCE OF OPERATION	
CLEARANCE.....	12	PARTS/ LEGEND SHEET	
CURBING (OUTDOOR MOUNTING) ....	12	SCHEMATIC	
INSTALLATION SAFETY .....	13	GAS TRAIN / BURNER SPECIFICATION	
GAS PIPING .....	13	COIL PERFORMANCE REPORTS (IF APPLICABLE)	
DUCTWORK.....	14	START-UP PROCEDURE	
SOUND AND VIBRATION CONTROL ..	14	TROUBLESHOOTING (OPTIONAL)	
DISCHARGE TEMP SENSOR BULB		<b><u>SUPPLEMENTAL MANUALS</u></b>	
INSTALLATION & WIRING .....	15	DX, CW, HW AND STEAM COIL	
FIELD WIRING.....	15	INSTALLATION & MAINTENANCE (IF APPLICABLE)	
<b><u>UNIT AND ACCESSORY INSTALLATION</u></b>		EVAPORATIVE COOLER (IF APPLICABLE)	
UNIT & ACCESSORY SUPPORTING			
OPTIONS.....	16		
SECTION ASSEMBLY-HORIZONTAL	17-18		
SECTION ASSEMBLY-VERTICAL ..	19-21		
ACCESSORY INSTALLATION .....	22-23		
INTAKE DAMPER MOUNTING .....	24		
DISCHARGE DAMPER MOUNTING.....	24		
VERTICAL DISCHARGE DIFFUSER			
MOUNTING .....	25		
<b><u>MAINTENANCE</u></b>			
GENERAL MAINTENANCE .....	26		
FILTERS .....	26		
BURNER .....	27		
GENERAL V-BELT DRIVE TIPS .....	28-29		
BLOWER BEARINGS .....	30		
MOTOR BEARINGS .....	30		

Note that operating and service manuals are occasionally requested prior to production of a unit. These manuals will be marked "Pre-Production Release" on the front cover.

The final copy of the operating and service manual for a specific unit will be sent with the unit. Additional copies of the manual for a specific unit are available.

A detailed unit specification sheet, parts/ legend sheet, schematic, sequence of operation and start-up procedure are provided in the start-up section of each operating and service manual generated for a specific unit. Selected vendor cut sheets on components will also be included.



## EQUIPMENT ARRIVAL

When the air make-up unit arrives, be sure to inspect for shipping damage. The equipment was thoroughly inspected before leaving the factory. Also upon receipt check the shipment for items which shipped loose such as a remote box and remote sensors. Consult the Bill of Lading to identify the potential shipped loose items. It should be noted that these items may have been placed inside unit cabinet in multiple locations; however, more often than not, shipped loose items can be found in the blower section of the unit. Any damaged or missing items should be reported to the transporter immediately. **DO NOT SEND DAMAGED FREIGHT BACK TO TITAN AIR! All claims must be filed with the transporter.** Be sure to take photographs and get the driver's signature to confirm the damage. The driver will have a number for you to call to file a claim. Request a written inspection report from the carrier claims inspector to substantiate any necessary claim. Be sure to open the unit access doors and inspect for internal damage.

## STORAGE

If for some reason you are unable to install the equipment immediately, be sure that the equipment is protected from the elements. Water damaged parts are not covered by Titan Air's warranty. If the equipment is stored for an extended length of time, be sure to completely check the unit for any internal damage which may have been caused by excessive condensation. Also check for damage caused by rodents, and be sure to eliminate any dust that may have built up on the components while the unit was in storage.

### LONG TERM STORAGE

Please observe the following precautions if the unit is to be stored for an extended period of time. (NOTICE: The time elapsed during storage still counts against the warranty period.)

- Best place to store the equipment is on a clean level surface, in a dry location where the temperature can be controlled, if possible.
- Cover direct fired burner to prevent water, dust and other contaminants from entering into the burner which could result in damage to the gas train.
- Isolate equipment from shock and vibration or damage may occur to the stationary blower bearings.
- At least once a month enter the blower vestibule and slowly rotate the blower wheel about 30 times to redistribute the grease inside the bearings to help prevent corrosion from occurring.
- Reduce belt tension by at least 50% or remove belts completely.
- Do not allow coverings to trap moisture against unit casing.

## CAREFULLY AND THOROUGHLY READ TITAN AIR'S PRODUCT WARRANTY

Each unit is tested at the factory prior to shipping. Because we are not able to simulate exact field conditions and sometimes actual conditions are different than what was stated on the order, you may need to make some adjustments in the field. This is why it is very important that only qualified personnel start-up and service Titan Air equipment. The start-up checklist (provided in packet with this manual) must be filled out and returned to Titan Air in order to validate equipment warranty.

For a fee, Titan Air personnel will travel to the job site, supervise start-up and provide operation and maintenance training for the equipment.

## COMPONENTS

### BLOWERS

The typical blower(s) used in Titan Air equipment are AMCA rated industrial type forward curve D.W.D.I. fans. Backward incline, backward airfoil, and plenum/plug fans are used occasionally. Models TA-109 through TA-136 utilize a single blower while models TA-215 through TA-242 utilize twin blowers. All blower wheels are mounted on a solid, turned, ground and polished shaft. 9" and 12" blowers are supported with permanently lubricated ball bearings. Larger blowers are supported by relubricatable pillow block ball bearings.

### MOTOR & DRIVE

Rigid base, T-Frame, motors are utilized. The motor is mounted on an adjustable slide base. Equipment furnished with a supply VFD will typically have a fixed motor sheave. However, some equipment may still utilize a variable pitch motor sheave.

## DIRECT FIRED HEATING

### BURNER OPERATING PRINCIPLES

The direct fired burner is designed to operate in a cabinet of flowing fresh air. Fuel gas is fed directly to the burner; kinetic energy of the airstream furnishes combustion air. It will function properly at the design velocity and pressure associated with ventilating systems.

The burner must be installed to fire with, and parallel to, the air flow. By virtue of velocity impact and suction generated by the diverging shape of the combustion baffles, air is induced through the air ports into the combustion zone. Although the air supply to the burner combustion zone is constant, only some of the air is actually mixing with the gas to produce combustion.

When a very small quantity of gas is admitted to the burner, sufficient mixing takes place in the low fire slot where combustion takes place. Since the low fire zone is contained within the burner casting it is effectively shielded from uncontrolled air entry.

As the gas supply is increased the flame progresses into the intermediate fire zone where an additional supply of air is available. At higher or full capacity, mixing occurs at the larger air ports of the high fire zone augmented by air flowing over the end of the baffles.

On a reduction of gas supply the reverse sequence takes place, the flame recedes to a location of lesser air supply until the low fire zone is reached. The burner is suitable for a turndown range of approximately 30 to 1.

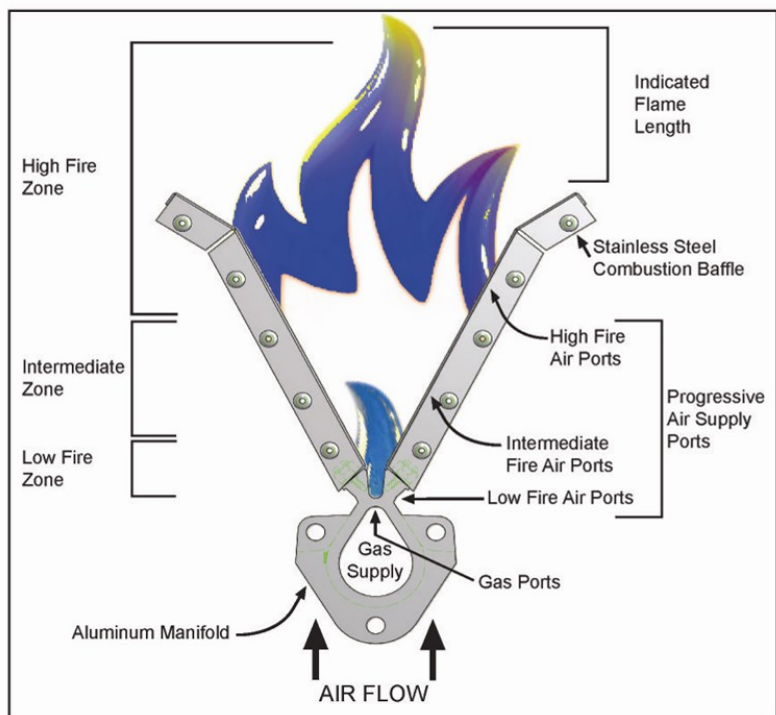

Note: Low fire air ports in casting are only present on Midco burners. Figure 1



### AIR SUPPLY

The supply fan is typically positioned to draw air across the burner. Air flow across the burner must be substantially straight (laminar) and velocity must be within the proper range to develop the desired turndown and capacity.

The direct fired burner is designed to operate in a Demand-Air™ unit with all air crossing the burner taken directly from outdoors. Rare exceptions involve equipment that serves an unoccupied space.

Total pressure rating of the blower includes allowance for the pressure drop through the primary air handling unit including the burner, together with pressure losses at the inlet screen, inlet damper, filters, outlet damper if used, plus the external pressure rating of the system.

### BURNERS

Burners are purchased in 6" and 12" straight lengths and 12" tee sections and are assembled to meet the BTU requirements of each piece of equipment.

According to national safety standards, the following factors could influence safe operation of a direct fired air make-up unit and must be interlocked to either prevent the burner from firing or shut it down if unsafe conditions occur.

1. AIR SOURCE – If a damper is used, it must be interlocked to prove it is open before the blower can start.
2. BLOWER STARTER/VFD INTERLOCK – A contact proving that the blower starter is energized or VFD is operating must be incorporated to prevent burner operation when the blower is not operating.
3. AIR FLOW SWITCHES – Monitor the air flow (pressure drop) across the burner. The switches (one high differential and one low differential) will not allow burner to operate if air pressure drop across burner is outside of the high and low set points.
4. HIGH TEMPERATURE LIMIT – A manual reset high temperature limit control must be utilized to prevent high temperature situations caused by excessive fuel pressure or lack of air flow.
5. FLAME SAFEGUARD – Monitors the combustion process during ignition and operation for safe conditions.
6. HIGH GAS PRESSURE SWITCH – Monitors gas pressure to the burner. This de-energizes the burner in the event gas pressure increases above its set point.

### GAS CONTROLS

Titan Air TA Series equipment is constructed to meet ANSI Z83.4/ CSA 3.7 standards. Components in the gas delivery manifold on standard equipment include: two manual shut-off valves, gas pressure regulator, two safety shut-off valves and an electronic gas modulating valve. The pilot control includes a shutoff valve, gas pressure regulator and a pilot solenoid.





### ELECTRIC /ELECTRONIC CONTROLS

Demand-Air™ units come standard with the following items: disconnect switch, variable frequency drive, control power transformer (if a 3 wire system), air proving switches, high temperature limit, electronic flame safeguard and electronic flame modulation with remote user interface. Low temperature limit and inlet duct stat functions are included in standard Demand-Air™ control packages.

Control systems can be designed to meet specific requirements. Numerous VFD speed control options are available. Titan Air utilizes a programmable controller on Demand-Air™ equipment to add limiting capability to the control of the modulating gas valve as air volume is reduced. ANSI standards for direct-fired variable air volume equipment require gas valve limiting as supply volume is reduced. The most common programmable controllers are Carel with associated PGD Graphic Display.

Titan Air units are typically supplied with a remote control panel. This panel includes a digital user interface for set point entry, mode indication, sensor displays and alarm indication. An "Auto-Off-On" switch is typically provided to allow the start function to be from the remote panel or from an external contact closure.

Refer to the unit specification sheets, parts list, schematic, sequence of operation and start-up procedure for a specific unit to determine the control options included.

**IMPORTANT:** If the malfunction of the heater creates a hazard to other fuel burning equipment in the served building (i.e. supplying make-up air to boiler room) it is to be interlocked to open an inlet air damper in case of failure.



## AIR FLOW SWITCH OPERATION

### BURNER PROFILE AIR PRESSURE DROP

ANSI standards, Z 83.4/CSA 3.7 require manufacturers to monitor air moving across the burner for both high and low conditions. Titan Air utilizes air pressure drop across the burner to satisfy this requirement.

Certification testing demonstrated that the burner will function properly between a low pressure drop of 0.15" w.c. and high pressure drop of 0.95" w.c. The standards also mandate that the switches cannot be adjustable. This makes air pressure drop across the burner profile a very important factor at initial start up.

The design burner pressure drop at standard air conditions is 0.60" w.c. and will change as the temperature of outside air increases or decreases from 70°F. In order for the burner to operate within the range of the air flow monitoring switch set points, the pressure drop should be as close to 0.60" w.c. as possible with the VFD operating at 60 Hz and the burner profile dampers fully open.

Air pressure drop across the burner profile is dependent on OA temperature. When the burner is off, pressure drop will climb significantly during cold weather. The burner is always off on initial start-up. Therefore, if the burner profile air pressure drop at maximum supply volume is above 0.70" w.c. during a warm weather start-up, it may exceed 0.95" w.c. during a cold weather start-up in northern regions. Such a high air pressure drop would open the high airflow switch and prevent burner ignition.

The following chart will aid in equipment set up at outside air temperatures different from 70°F when the unit is operating with the burner off. The chart gives pressure drops, at various temperatures, equivalent to 0.60" w.c. at 70°F.

Demand-Air™ units feature controls to automatically control pressure drop across the burner as air volume changes. Burner profile air pressure drop should be measured with the VFD operating at 60 Hz. and burner profile dampers fully open. If properly functioning burner profile dampers do not open fully, the unit is probably delivering less than full rated airflow.

**Burner Profile Air Pressure Drop at Various OA Temperatures (Burner Off)**

OA Temp (°F)	Burner Profile Drop (w.c.)	OA Temp (°F)	Burner Profile Drop (w.c.)	OA Temp (°F)	Burner Profile Drop (w.c.)
-40	0.76	10	0.68	60	0.61
-35	0.75	15	0.67	65	0.61
-30	0.74	20	0.66	70	0.60
-25	0.73	25	0.66	75	0.59
-20	0.72	30	0.65	80	0.59
-15	0.71	35	0.64	85	0.58
-10	0.71	40	0.64	90	0.58
-5	0.70	45	0.63	95	0.57
0	0.69	50	0.62	100	0.57
5	0.68	55	0.62	105	0.56



# INSTALLATION

## PRE-INSTALLATION

Inspect the equipment making sure all parts and accessories are on the job site. Check equipment against order and packing list. If the equipment has been sitting in storage for some time, inspect it for moisture (from condensation, rain or snow) and/or dust accumulation. Both can cause damage to electrical and electronic components as well as bearings and insulation.

### INSTALLATION CODES

Care taken during the installation and start-up is vital to the longevity and reliability of the equipment. Confirm that gas and electric utilities match the rating on the equipment name plate.

- This heater shall be installed in accordance with local codes or, in the absence of local code, according to National Fuel Gas Code, ANSI Z223.1/ NFPA 54, or the CAN/ CGA B149.1 Natural Gas and Propane Installation Code.
- If the heater is to be installed in an airplane hangar, refer to ANSI/NFPA 409.
- If the heater is to be installed in a parking garage, refer to ANSI/NFPA 88A.
- If the heater is to be installed in a service garage, refer to ANSI/NFPA 88B.
- For installations in Canada, refer to CAN/CGA B149.1 National Gas and Propane Installation Codes.

### INSTALLATION PREREQUISITES

- The heater inlet shall be located in accordance with the applicable building code provisions for ventilation air.
- All air to the heater must be ducted directly from the outdoors. Recirculation of room air is not permitted.
- Adequate exhaust and/or relief must be provided to prevent over pressurizing the served space when the heater is operating at its rated capacity. It should be noted that this can be accomplished by taking into account, through standard engineering methods, the structure's designed infiltration rate; by providing properly sized relief openings; or by interlocking a powered exhaust system; or by a combination of these methods.
- Heaters installed with intake ductwork must purge at least four air changes the volume of the intake ductwork prior to an ignition attempt.
- If in doubt regarding the application of the direct fired heater, contact the sales representative or the factory.



# INSTALLATION

## POSITIONING THE HEATER

Locate the heater exactly level, making certain minimum clearance required by local codes is maintained between the heater and any combustible materials. See name plate on unit for minimum recommended clearances.

When the makeup air equipment is located on a roof or at ground level on a concrete pad, the unit intake needs to be a minimum of 24" above the roof and/ or ground to prevent the intake of snow or splashed rain. The unit should be located in such a way to prevent prevailing winds from blowing directly into the unit intake. If the application is critical, provisions must be made to protect the unit inlet from the driving winds.

## CLEARANCE

Select the installation location and support system (curb, stand or other) that meets or exceeds all of the minimum safety clearance requirements.

### BOTTOM

Unit should be installed to allow clearance for proper condensate trap (If applicable). Do not install unit on combustible surfaces.

### SIDES

The minimum recommended clearance on all sides of the unit except for the service side and bottom is 6 inches.

### SERVICE

The service side should have a minimum of 24 inches of clearance; however it is recommended that the clearance be at least the width of the widest door.

Also, if the unit includes any coils or has twin blowers more clearance should be provided for removal of those components.

The minimum clearances listed above are set, in place, by the standard in which Titan Air builds their equipment to meet; however, one should consult with all authorities having jurisdiction to ensure they don't require larger clearances. Furthermore, the unit must be installed in such a way to facilitate smooth operation and maintenance of all built in sections and components. Also, it should be noted that the coil pull could be located on either side of the unit. Review the unit submittal drawing for the correct direction of the coil pull.

## CURBING (OUTDOOR MOUNTING)

The use of a full perimeter curb or mounting rails under the heater is recommended. The only openings in the roof should be for the supply air duct, return air duct (if required), gas and electrical connections (if applicable). These openings must be sealed properly after installation. Titan Air ships all curbs unassembled and un-insulated. Installing contractor supplies gaskets, cant strips, insulation, etc.



# INSTALLATION

## INSTALLATION SAFETY

### RIGGING

- **DANGER:** Never enlarge lifting lug hole to accommodate larger anchor shackle.
- **WARNING:** Never assemble unit sections or sub-assemblies together before rigging. Always rig unit the way it was shipped from the factory.
- **CAUTION:** It is the installer's responsibility to confirm that the lifting equipment capacity exceeds unit weight by an adequate safety factor. Never stack inlet hoods or other components onto the unit **as the unit is being lifted.**
- **IMPORTANT:** Apply appropriate sealant to roof curb and duct adapter(s) prior to setting the unit in place (If applicable).

### Lifting Requirements:

- Protect coil connections, extending through unit casing, from damage by the rigging cables through the use of plywood or other suitable materials.
- Exercise care when moving the unit.
- Rig the unit using **ALL** the lifting points, in a fashion that holds it level and prevents it from tipping, falling and/ or twisting.
- Spreader bars of sufficient width **MUST** be used across the top of the unit, to ensure that the lifting cables clear unit cabinetry.
- Utilize the same rigging and lifting methods as the ones applied to the unit, for lifting the accessories.
- Remove all wooden shipping blocks before setting unit(s) onto curb (If applicable).
- After sections are set in place, assemble according to Unit Section Assembly (If applicable).
  - **NOTICE:** Warranty does not cover damage from the unit being severely twisted or dropped during handling.

## GAS PIPING

Gas piping must be sized and installed in accordance with applicable codes. It must be able to deliver the specified CFH and gas pressure at full flow. Refer to unit nameplate or unit specification sheets for specified CFH and gas pressure.

Care must be taken with the gas piping to prevent problems at start-up and later during operation. Before the union between the supply line and the unit is connected, the supply line should be cleaned out to remove any foreign material (dirt, rust, metal shavings, etc.) and a drip leg should be utilized.

Refer to unit nameplate to determine the minimum gas supply pressure required to attain the maximum specified gas.

All suitable gas controls, regulators and valves (equipped with a diaphragm) in this unit are furnished with an ANSI approved vent limiter. If local codes require these components be vented to the outside, it is the responsibility of the installing contractor.



# INSTALLATION

## **GAS PIPING Contd.**

**CAUTION:** The heater and its individual shut off valve must be disconnected from the gas supply piping system during any pressure testing in excess of ½ PSIG.

**CAUTION:** The heater must be isolated from the gas supply piping system by closing its individual shut off valve during any pressure testing of the supply system at pressures equal to or less the ½ PSIG.

The heater must be isolated from the gas supply piping system by closing its individual shut off valve during any pressure testing of the supply system at pressures equal to or less the ½ PSIG.

During start-up, the technician should perform a gas leak check on all valves and piping during the heater's normal operation. (See page 34)

## **DUCTWORK**

Ductwork must be sized and installed in accordance with applicable codes and standards. As a recommendation follow SMACNA guides for proper ductwork design, size and installation. A size variation may exist from recommended duct size to unit or accessory flange size. Accessories on the unit intake or discharge may be larger than the openings on the unit. Be sure to check the unit submittal drawing for the correct equipment connection size. Recommended duct size applies to the size of the duct at the connection to the equipment. Factory also recommends 2 1/2 times the equivalent duct diameters of straight ductwork off the discharge outlet of the blower. A properly designed duct transition from the blower outlet to a larger duct is recommended for long ducts or ducts with numerous elbows. The unit was designed for a specific CFM and ESP (External Static Pressure) stated on unit rating plate. The ductwork attached to the unit will significantly affect its performance.

On heaters mounted outdoors, discharge ductwork should be insulated to minimize condensation during the "off" cycle in cold weather. A fresh air intake hood with bird screen is required. Discharge ductwork on a twin blower unit must be common to both blowers.

On a heater mounted indoors with through the roof intake, a "mushroom" type intake hood is recommended to prevent moisture entrainment. When using "through the wall" intake duct, the intake louver should have adequate moisture baffling characteristics. All intake ductwork exposed to the heated space should be insulated. Also any ductwork passing through unconditioned spaces must be insulated and covered with a vapor barrier.

Factory not responsible for field retro fits due to difference of the actual ESP from the designed ESP.

## **SOUND AND VIBRATION CONTROL**

Use of flex coupler between building ductwork and air makeup unit is highly recommended. Vibration isolators that mount between the unit and support structure are optional and can be supplied with the equipment for installation by others. Another option is internal isolation of the blower/motor assembly with internal flexible connections between the blower housing and the unit structure.

Appropriate insulation on the interior of ductwork significantly reduces sound levels.



# INSTALLATION

## DISCHARGE TEMPERATURE SENSOR BULB INSTALLATION & WIRING

The installing contractor may be responsible for field installation of the discharge temperature sensor. Install discharge temp sensor at least five duct diameters away from the unit discharge to provide ample mixing of tempered air. Field installation of the discharge temperature sensor in the discharge ductwork results in a better measurement of the average supply air temperature. **Utilize shielded cable for field installed discharge sensor wiring.**

## FIELD WIRING

Power supply wiring should be routed from a dedicated branch circuit per schematic. Depending upon how the equipment was ordered, a single point power connection may be subdivided to individual loads or multiple power supply circuits may be required.

If an intake or discharge damper was ordered as a loose accessory, it will have to be mounted as specified in the Damper Installation Instructions found on page 24 and the actuator must be wired. The remote panel must be mounted in a convenient location and wired to the unit. Interlocks between the exhaust, unit and possibly spray booth will have to be connected by field wiring.

Carefully review the schematic and associated schematic symbol legend. Note that legend may be on the parts/legend sheet rather than on the schematic. Most Demand-Air™ remote panels will have a digital user interface that must be wired back to the controller in the unit with twisted/shielded communication wiring.

Many codes require that low voltage wiring (terminals 100+) be routed in separate conduit from line voltage wiring. If low voltage wiring is routed with 120 VAC control voltage wiring, it must be placed in shielded cable(s) with appropriate insulation rating. Even if low voltage wiring is routed in separate conduit, very low voltage sensor outputs and actuator control signals should be routed in shielded cable.

- NOTE: All field wiring must conform to N.E.C. and/or any state or local codes.

## POST INSTALLATION

Sealing integrity should be rechecked on a yearly basis. Most of the unit will likely be under a negative pressure when the blower is operating. Dirt and moisture can be drawn into the unit. Check for water in outdoor units after operation during a rain shower. *Water damaged parts are not covered by Titan Air's warranty.*

## Horizontal Unit-Supporting Options Curb

Curbs are to be assembled in the field.

Assemble according to the letters marked on the top of each curb piece using factory supplied fasteners.

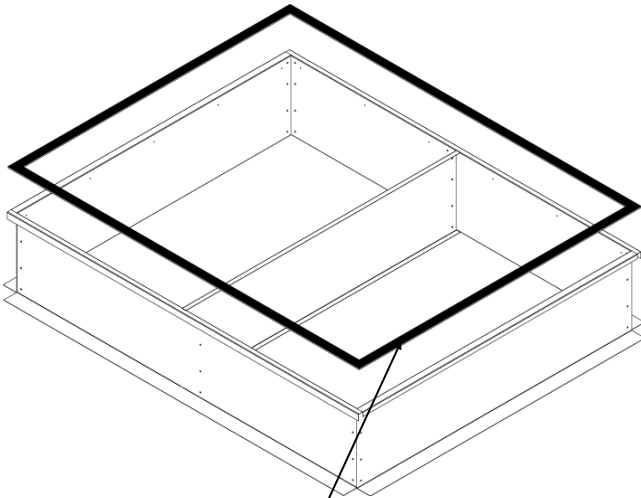

Caulking or Gasket material  
(supplied by others)

## Accessory- Horizontal Unit Supporting Options

Recommended option for supporting accessories on a flat roof:

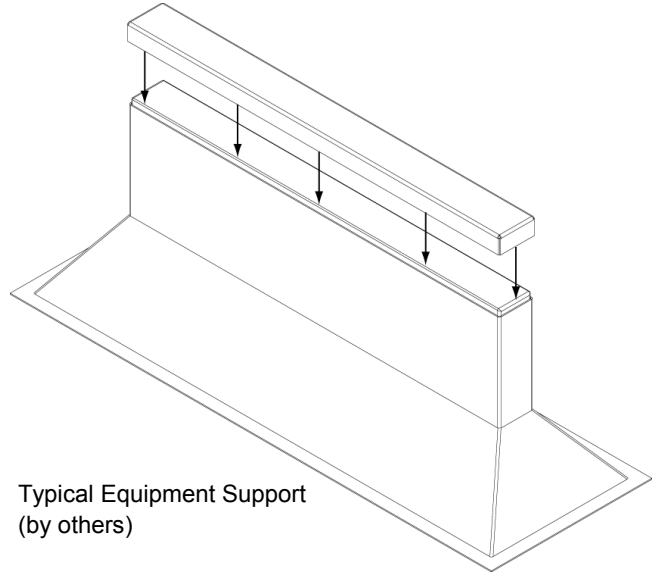

Typical Equipment Support  
(by others)

Other method of installation using sheet metal support legs.

- **IMPORTANT:** Not recommended for any unit larger than 125 model.

Attach support brace to accessory seam using field supplied fasteners.

Bent, 16 gauge (if supplied by factory), sheet metal support brace.

6 X 6 inch sheet metal pad welded to the support brace (if supplied by factory)

Wood Block (supplied by others)

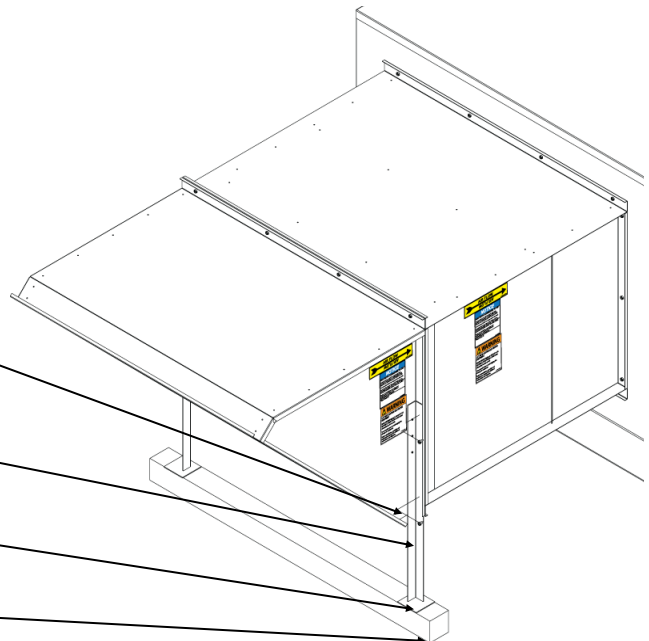



## MULTI-SECTION EQUIPMENT

### Horizontal Configuration

#### Before beginning:

Be sure to check the tightness of all bolts, nuts and setscrews, which could have loosened during shipping.

Rotate blower fan shaft(s) by hand to make certain there is no interference or rubbing between components.

Verify installation surface is level before proceeding with unit installation.

#### Locate mounting hardware:

Items included: Caulk, Caulk Tape, Fasteners

Check all sections, of the unit, thoroughly for assembly hardware. The assembly hardware will be found packaged in either a clear plastic bag or corrugated box.

- NOTICE: There may be more than one package of assembly materials provided.

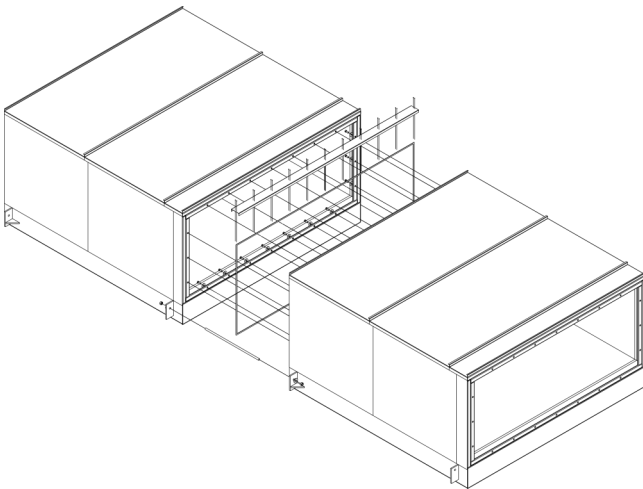

1. Apply provided caulk tape to the face of the joint to be bolted together, on one side only as shown below, before assembly. Ensure there are no gaps in the caulk tape when applying. **Do not** cover bolt holes with caulk tape.

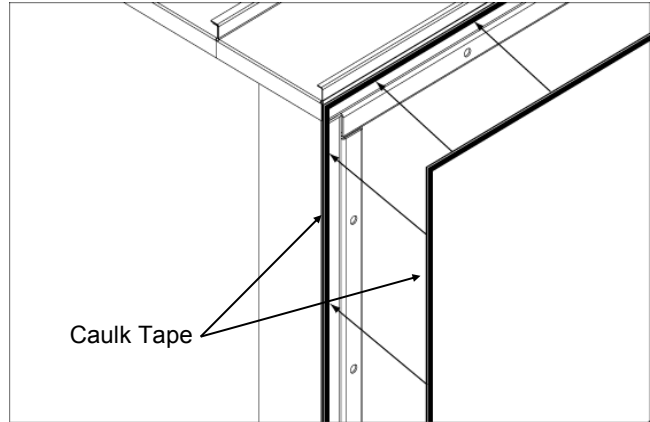

2. Locate and match each section letter on the service side of the unit with the corresponding letter on the other section. In addition, also refer to the unit submittal drawing for proper assembly order.



3. Pull sections together at the lifting lugs using, two, half inch rods w/ nuts and large washers as shown below.

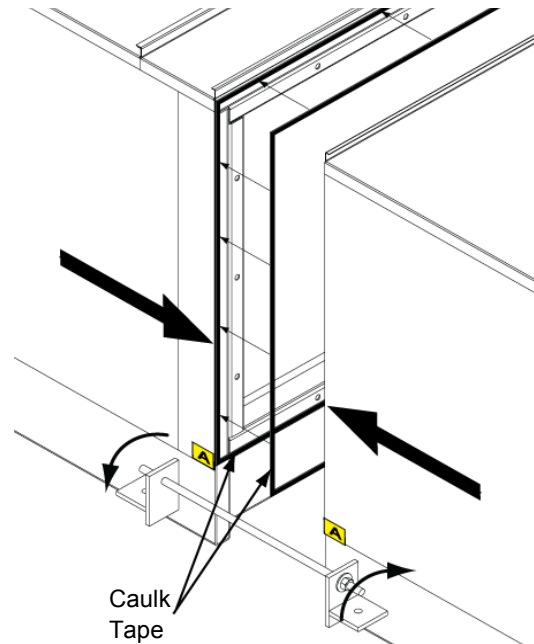

4. Use the provided fasteners to secure the seam at the top and bottom before setting the next section into place.

- **IMPORTANT:** Use all of the bolt holes in the seam for joining the unit sections together and then tighten accordingly.

Trim off the excess caulk tape squeezed out of the joint at each unit joint to provide a clean appearance.

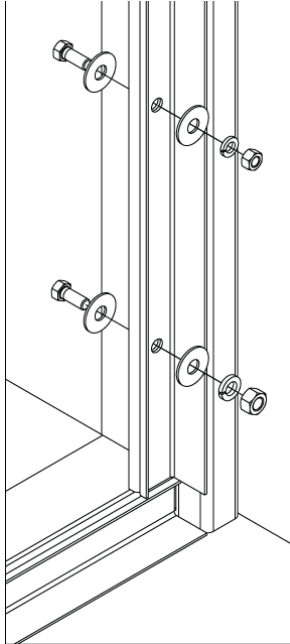

5. After all of the sections are bolted together, caulk the external section seam(s) to provide a water tight seal.

- **IMPORTANT:** Check all external sheet metal seams for caulk shrinkage and re-caulk if necessary. *Titan Air Inc. does not warranty water damage units.* Unit seam sealing integrity should be rechecked on a yearly basis.
- **NOTICE:** Access door swings **MUST** be kept free of installation piping and wiring to allow for service and maintenance.

## 6. Roof Cap Installation

Apply caulk to section roof tee before placing on the splice cap.

Fasten splice cap to roof tee using the provided self tapping screws from the top.

Caulk around all edges of the splice cap.

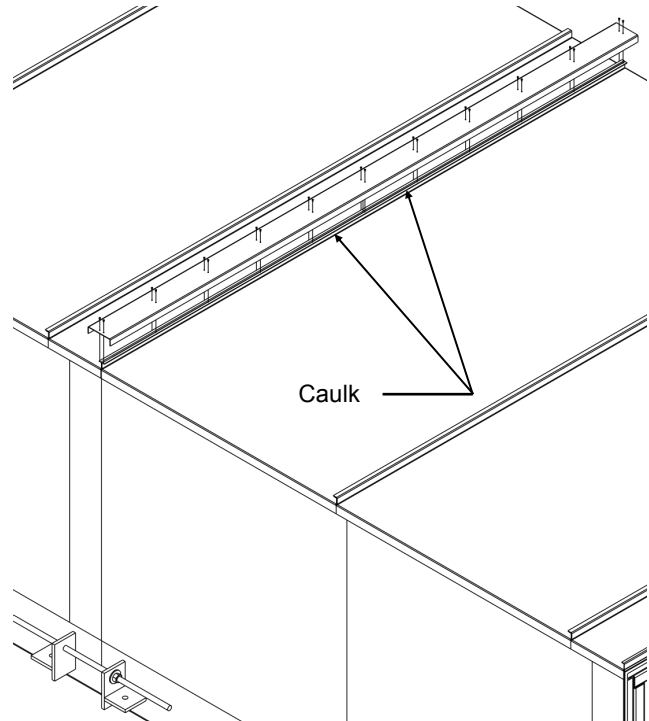

## MULTI-SECTION EQUIPMENT

### Vertical Configuration

#### Before beginning:

Be sure to check the tightness of all bolts, nuts and setscrews, which could have loosened during shipping.

Rotate blower fan shafts by hand to make certain there is no interference or rubbing between components.

Verify installation surface is level before proceeding with unit installation.

#### Locate mounting hardware:

Items included: Caulk, Caulk Tape, Fasteners

Field Supplied Hardware: Anchoring studs along with nuts and washers

Check all sections, of the unit, thoroughly for assembly hardware. The assembly hardware will be found packaged in either a clear plastic bag or corrugated box.

- NOTICE: There may be more than one package of assembly materials provided.

1. Anchor the stand on a level concrete pad using studs or by other means. Each stand foot pad needs to be secured.

- NOTICE: For indoor units, the stand must be enclosed (sometimes height is increased.) A transition (by others) must be made from enclosed stand intake opening to the intake damper or louver (a size variation may exist.)

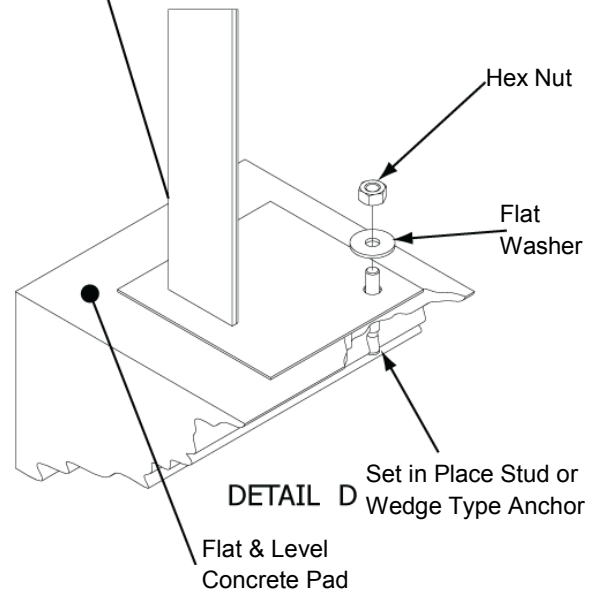
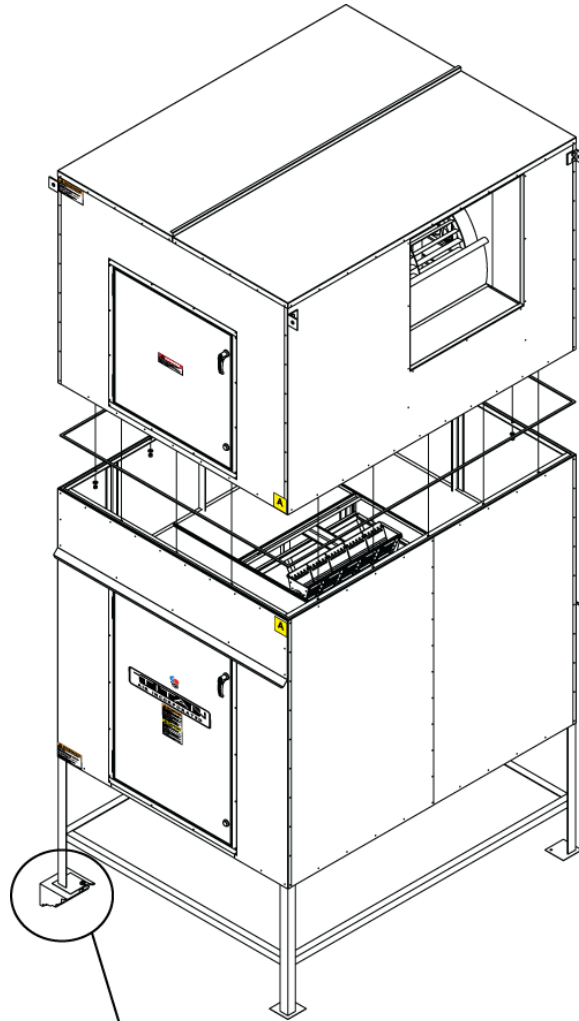

2. Apply provided caulk tape to one side of the joint to be assembled. Apply tape toward the outside of the bolt pattern as seen below. Ensure there are no gaps in the caulk tape when applying. **Do not** cover the bolt holes with caulk tape.

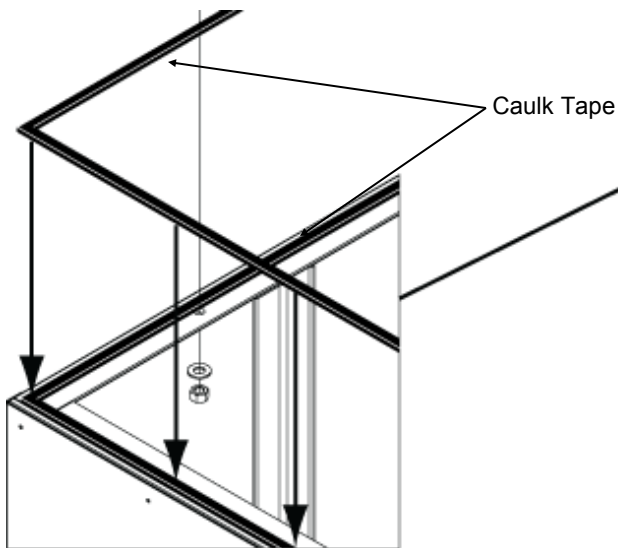

DETAIL H

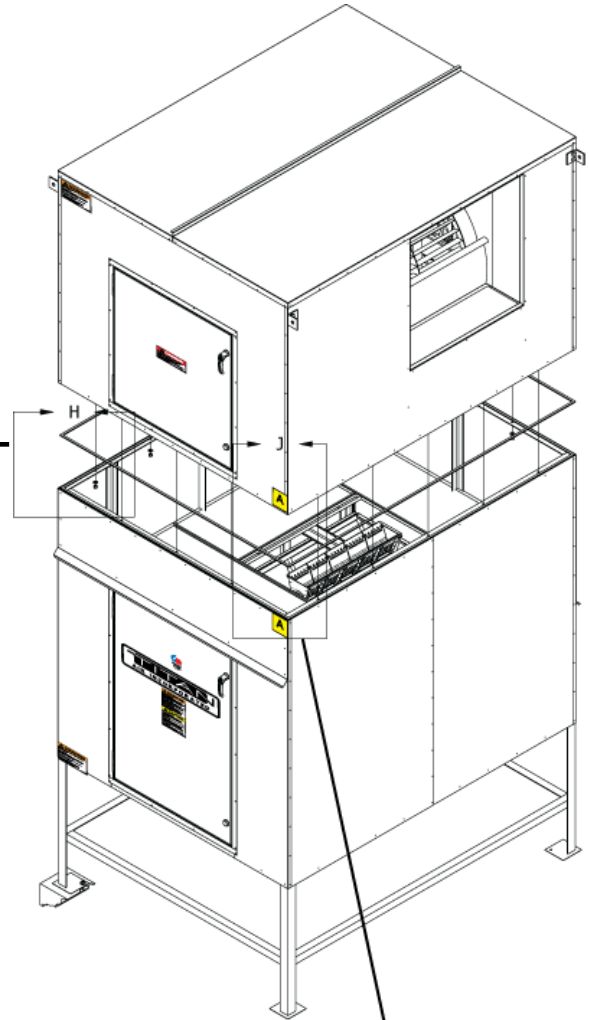

3. Locate and match each section letter on the service side of the unit with the corresponding letter on the other section. In addition, also refer to the unit submittal drawing for proper assembly order.

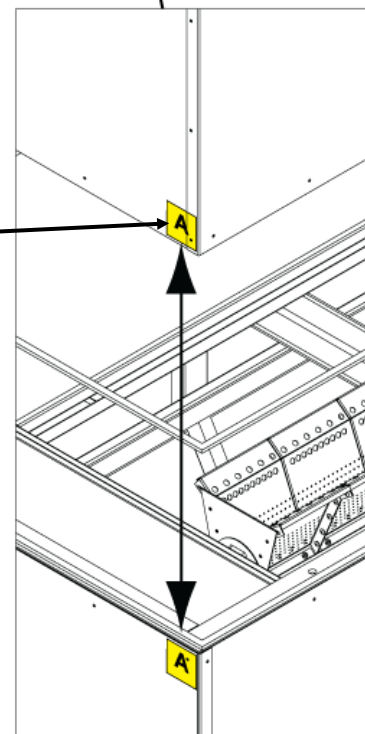

DETAIL J

4. Lift blower section and center it over burner section with the unit section letters lined up. After blower section is set in place use drift punches to line up seam bolt patterns. Fasten sections together using the provided bolts, nuts and washers filling all of the seam holes.

5. Caulk around the outside of each section seam.

- **IMPORTANT:** Re-caulk unit lifting lugs after assembly. Check all external sheet metal seams for caulk shrinkage and re-caulk if necessary. *Titan Air Inc. does not warranty water damage units.* Unit seam sealing integrity should be rechecked on a yearly basis.

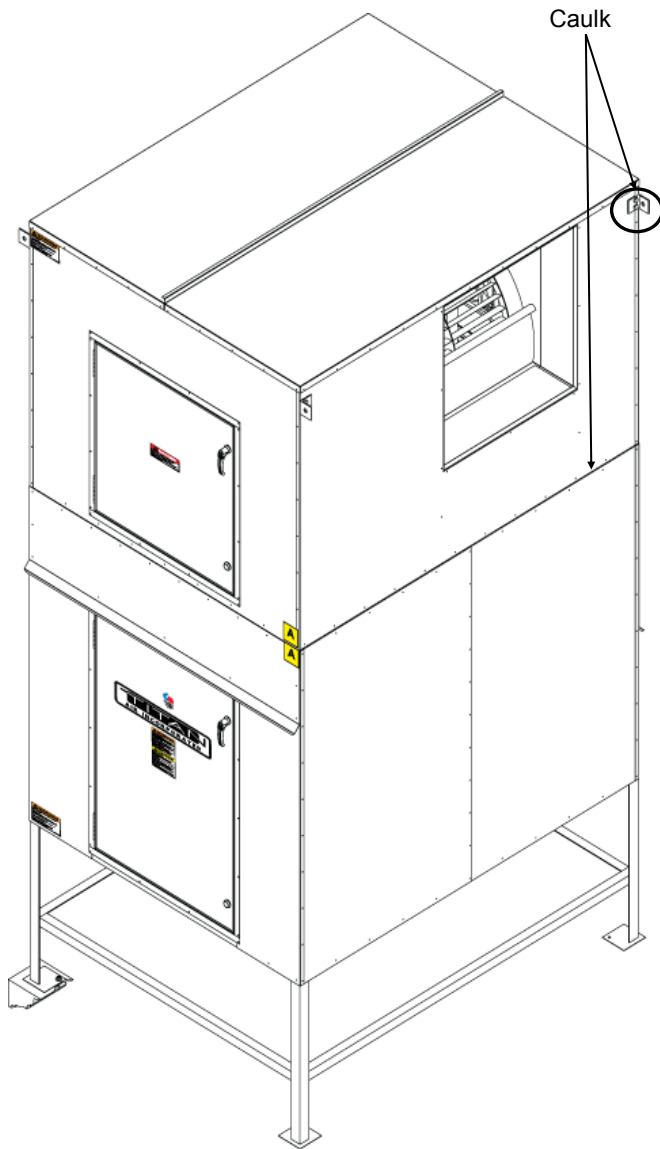

## Accessory Installation

**NOTICE:** Unit accessories may be larger than unit intake and discharge opening or flanges. Due to infinite installation possibilities, a section of ductwork or transition may be required for proper accessory mounting (by others).

**IMPORTANT:** Installer **MUST SUPPORT** accessory items from a rigid point or points to ensure solid mounting using field or factory supplied hardware.

**DESIGN CONSIDERATION:** Titan Air strongly recommends using a flex coupler between the AMU and Ductwork.

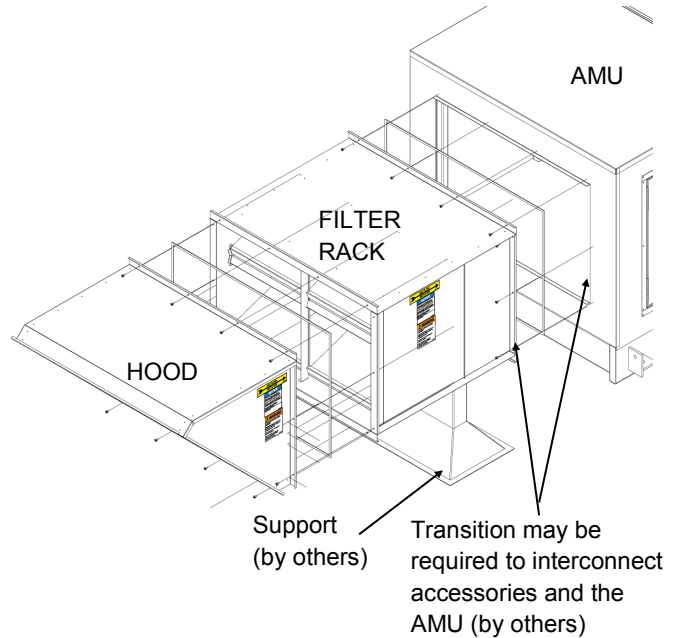

Refer to Field Wiring section, under the installation section, for instructions on wiring the damper actuators.

**Design Requirement:** If an intake hood is supplied by others, the design shall minimize entry of snow/ rain and include an intake screen to meet ANSI standards.

Accessories on large equipment may be shipped in two pieces for field assembly. As a result, two damper actuators may need to be field wired.

### Horizontal Unit

#### Before beginning:

Verify with roofing manufacture the method of installation preferred for supporting accessories (Rooftop Units Only).

#### Locate assembly supplies:

Items included: Support Brackets (optional)

#### Field supplied hardware:

Caulk, Caulk Tape, Fasteners (Self tapping screws and ¼ inch bolts/ nuts/ washers)

1. Match serial number on the accessory to unit name plate inside control vestibule door.

2. Check unit submittal drawings to verify if unit accessories need a transition to match up with the air handler unit intake or discharge opening.

<h2>NOTICE</h2>
<p><b>MUST MATCH ACCESSORIES TO UNIT</b></p> <p>Accessories are built to match and may contain construction or wiring differences that are not interchangeable between units.</p> <p>Accessories <b>MUST</b> be supported in the field.</p> <p>Accessories larger than unit intake and/ or discharge opening will require a field supplied ductwork transition unless otherwise stated.</p> <p>Refer to installation, operation and maintenance manual for additional instructions and diagrams.</p>
<p>Titan Serial #:</p>
1-14-101-02 (03/13)

3. Apply caulk tape (field supplied) directly to the flange, below the screw pattern of the joint to be fastened together.

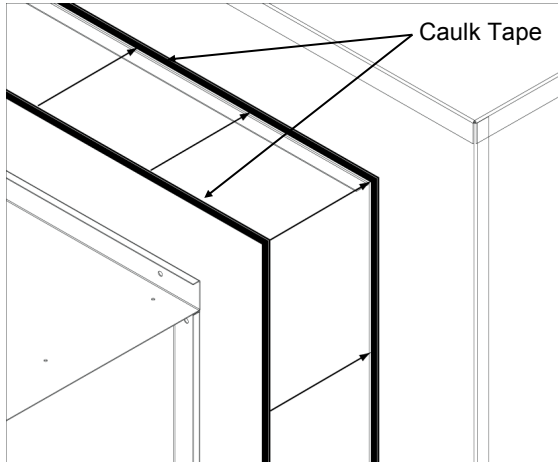

4. Hoist accessory using all lifting lugs, if provided; otherwise, a sling, to lift accessory and center it over the panel opening.

5. Affix the accessory to the unit using (field supplied) self tapping screws. Make certain every pre-punched hole in the flange is used in fastening.

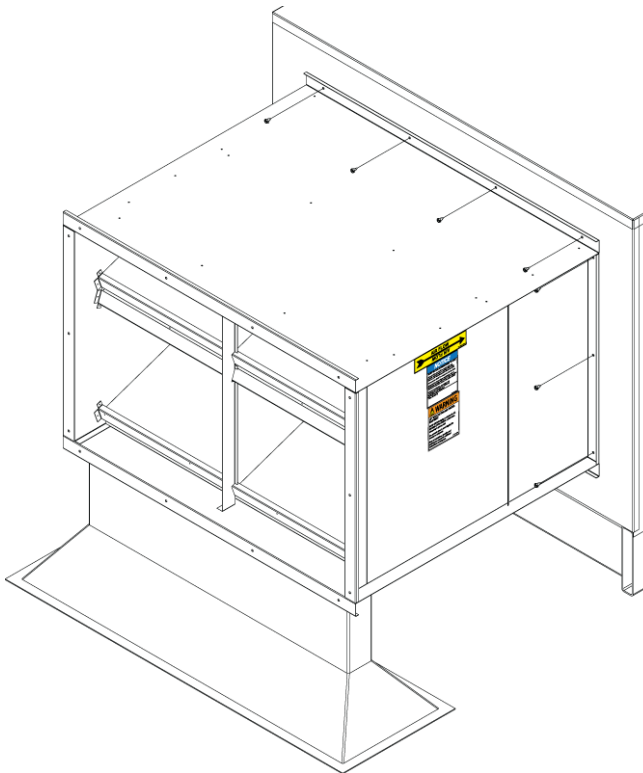

6. Repeat steps three through five to attach the hood to the filter section; *except in step five substitute 1/4 inch bolts in for self tapping screws to attach the hood to the filter section.*

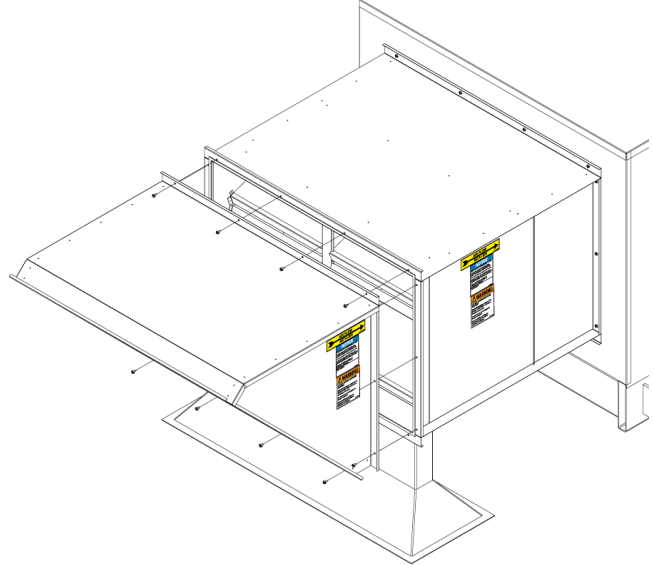

7. After all of the accessories are installed, caulk each seam to provide a water tight seal.

- **IMPORTANT:** Re-caulk accessory lifting lugs after assembly (if applicable). Check all external sheet metal seams for caulk shrinkage and re-caulk if necessary. *Titan Air Inc. does not warranty water damage units.* Seam sealing integrity should be rechecked on a yearly basis.
- **NOTICE:** Access door swings **MUST** be kept free of installation piping and wiring to allow for service and maintenance.

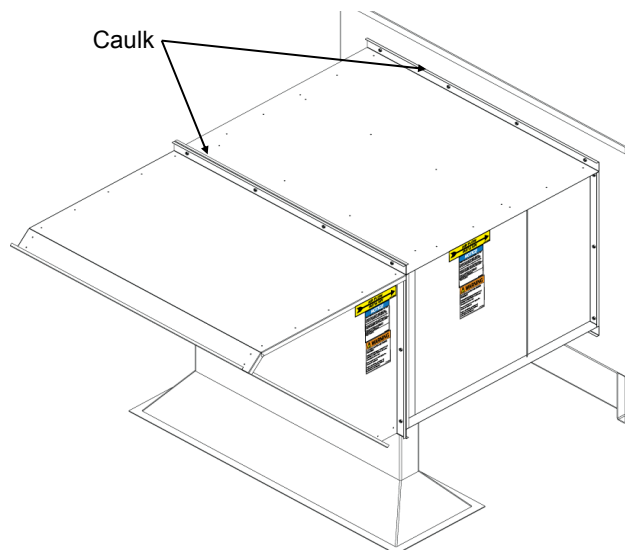

### Intake Damper Mounting

Follow the Horizontal Accessory Installation instructions for proper installation and the diagrams below for mounting location of the intake damper.

#### Indoor Installation Location:

**IMPORTANT:** Intake damper should be mounted at the building wall or ceiling.

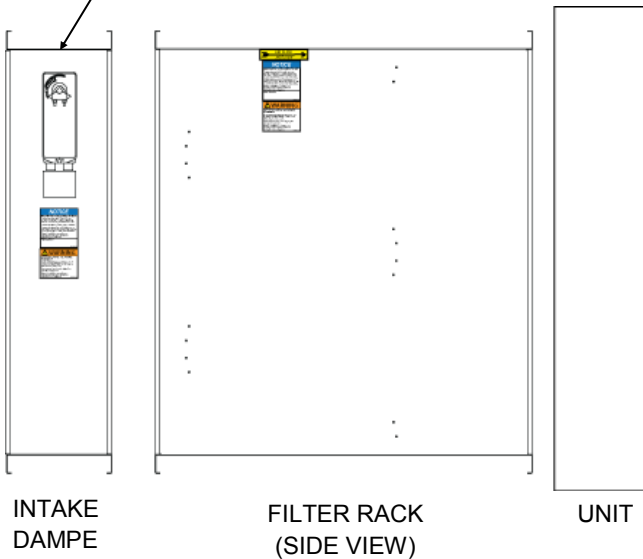

#### Outdoor Installation Location:

**IMPORTANT:** Titan Air recommends the intake damper be mounted with the damper actuator facing the service side of the unit. Make certain the damper actuator is **PROTECTED** from the outdoor elements with a sheet metal cover.

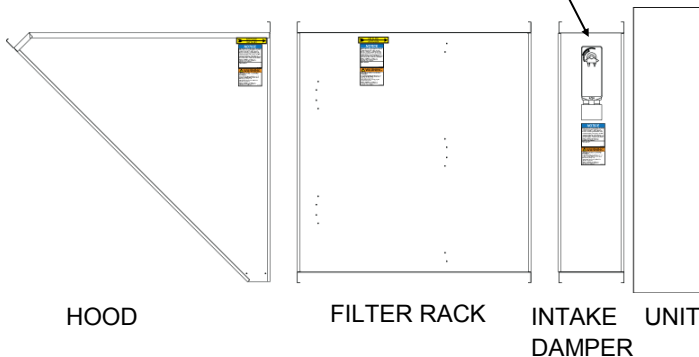

### Discharge Damper Mounting

Follow the Horizontal Accessory Installation instructions for proper installation and the diagram below for mounting location of the discharge damper.

**NOTICE:** If the Discharge Damper is being mounted within two to three duct diameters from the unit discharge opening Titan Air highly recommends the discharge damper be mounted so the blades are orientated vertically. (If possible)

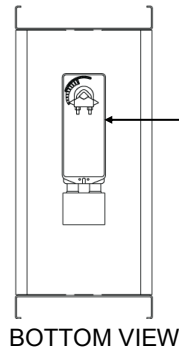
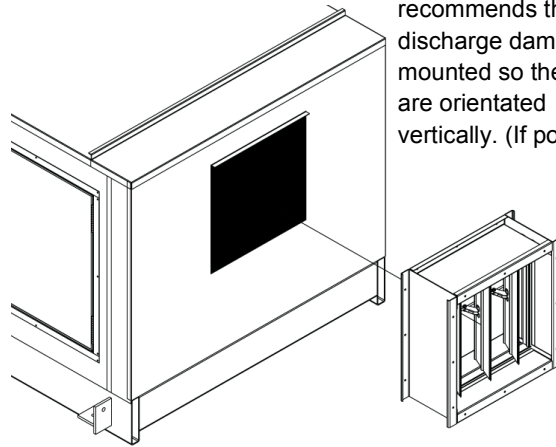

**IMPORTANT:** Titan Air also highly recommends the discharge damper be mounted at the wall or ceiling indoors. However, if the damper cannot be mounted indoors the damper actuator **MUST BE PROTECTED** from the outdoor elements (if applicable).



**Vertical Unit Discharge Diffuser  
Mounting and Supporting**

Ductwork between AMU and diffuser or discharge damper and diffuser is supplied by others.

Support diffuser at two points using field supplied materials (See example below).

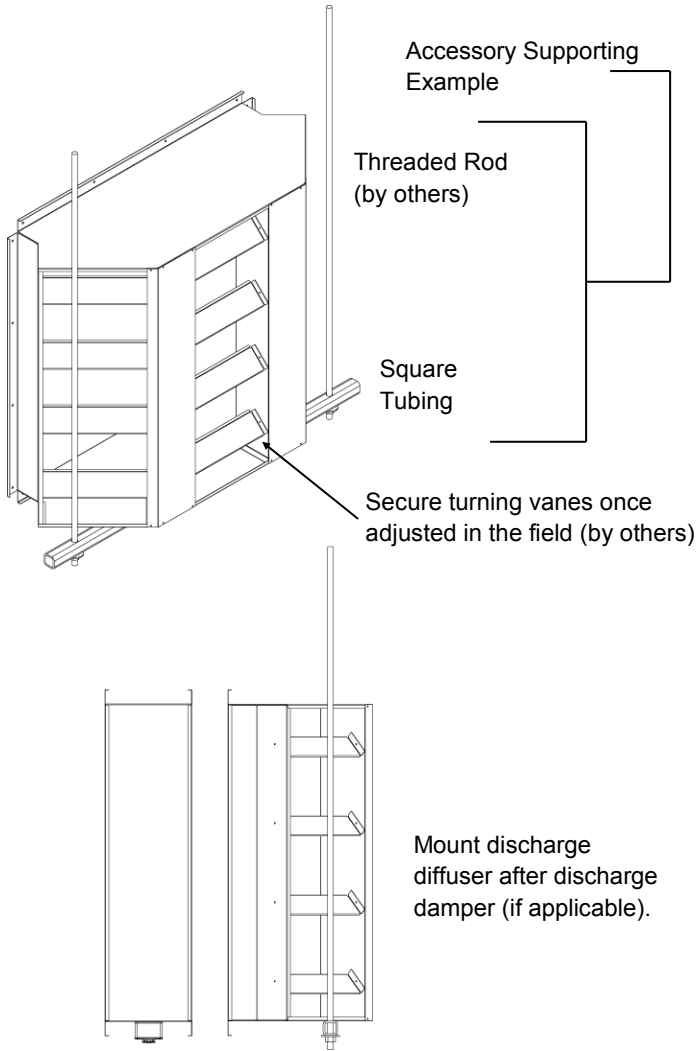



## GENERAL MAINTENANCE

Visit <http://www.titan-air.com/> and click on "Tools & Resources" for more detailed maintenance information.

As with any equipment or machinery, a maintenance program should be implemented.

### Equipment maintenance should include the following:

1. Check filters and clean or replace as needed.
2. Check burner and flame rod - clean if necessary.
3. Check belts, belt tension and sheave alignment. (Do not over tension.)
4. Confirm smooth operation of dampers.
5. Lube bearings.
6. Check all hardware (bearings, etc.) for tightness.
7. Check settings for all controls.
8. Check duct connections for leaks.
9. Re-caulk seams if needed.
10. Perform complete start-up procedure once per year (prior to heating season).

## FILTERS

Dirty or clogged filters will restrict air flow which in turn affects the equipment performance. Therefore, it is necessary to check filters on a regular basis. Several standard filter types are available including 2" pleated 30% efficient, 2" disposable fiberglass, 2" linked panel, and 1" or 2" cleanable filters.

Cleanable filters should be removed from the filter rack and sprayed with a low pressure water. Always spray these filters in the opposite direction to air flow and apply new coating to filters when dry.

Note that cleanable filters alone may not adequately protect a coil from dust and dirt accumulation.

Filters in an unheated outdoor airstream can "freeze-up" when the humidity is high (foggy) and temperatures are near freezing.

Method of Prevention:

Install pre-filters in the outdoor airstream that can be removed during such weather.



# MAINTENANCE

## BURNER

NOTICE: *Vertical Unit Burner Access:* Filter rack can be slid out through the unit door to allow access to the backside of the burner.

Maintaining the pilot assembly is essential to reliable operation. During pre-heating season maintenance, the burner should be lit numerous times to confirm reliability. If ignition system components require servicing, pay attention to the following:

1. Handle porcelain spark rod and flame rod with care. Small cracks lead to intermittent ignition problems.
2. Midco burners utilize the pilot gas tube as a ground point for the ignition rod. Keep this grounding point free from scale or other contaminant build-up.
3. Ignition wire routing should remain separated from sheet metal cabinet to maintain optimal spark strength.
4. Dielectric grease is utilized inside of the ignition and flame sensor connection boots to limit potential for moisture in the connection.
5. Maintaining low pilot regulator output pressure typically produces reliable ignition. Excess pilot pressure creates a gas rich region that will not ignite consistently.
6. The pilot solenoid is disabled following main flame ignition. The low fire setting must be high enough to maintain a proper amplified flame rectification signal.

Check that burner baffles are firmly attached to each other and to burner casting. Do not use excessive force on screws in casting. Clean baffles with wire brush if needed.

Burner orifices may need to be re-drilled due to rust or other build-up. Burners with aluminum castings will rarely require orifice cleaning. Use drill bit sizes listed below.

<b>Fuel Type</b>	<b>Burner Model</b>	<b>Orifice Size</b>
Natural Gas	Eclipse AH-MA	2.4 mm Bit
Natural Gas	Midco HMA-2 or 2A	1/8" Bit
LP Gas	Eclipse AH-MA	2.0 mm Bit
LP Gas	Midco HMA-2 or 2A	1/8" Bit
Low Fire Air Ports	Midco HMA-2 or 2A	#43 Bit

### GENERAL V-BELT DRIVE TIPS

Refer to website for more detailed information pertaining to belt maintenance.

- Keep the belts and sheaves free from foreign materials that may cause slippage or damage to the belt and sheave surfaces.
- Maintain sheave alignment.
- Inspect the V-belt drive periodically. Re-tension the drive belts if they are slipping.
  - ◆ NOTE: Optimal belt tension is the lowest tension at which the belts will not slip under peak load. Peak load typically occurs at start-up.
- Over tensioning belts can cause premature bearing, sheave and belt failure.
- Particular attention should be given to these conditions:
  - Worn groove sidewalls
  - Shiny sheave groove bottom
  - Wobbling sheaves
  - Damaged sheaves

### BELT TENSION

Proper sheave alignment and belt tension are critical to belt and bearing service life. Incorrect belt tension or misalignment of sheaves can cause any of the following:

- Premature failure of bearings.
- Premature failure of belts.
- Reduced air volume.
- Noise and vibrations.

Each Titan Air unit has as standard equipment an adjustable motor base. To adjust the belt tension, loosen the motor hold down bolts and adjust the slide base with adjusting bolt(s) on the end of the base (larger bases will have 2 adjustment bolts). Use a belt tension tester and associated tables to determine proper tension. Re-tension after the first day of operation with new belts and periodically thereafter.

Common belt tension gauges will specify a force required to produce a deflection of 1/64" per inch of span. The force required to achieve this deflection is typically in the range of 3 lbs for A-belts, 5 lbs. for B-belts, and 15 lbs. for 5V belts. See Figure below.

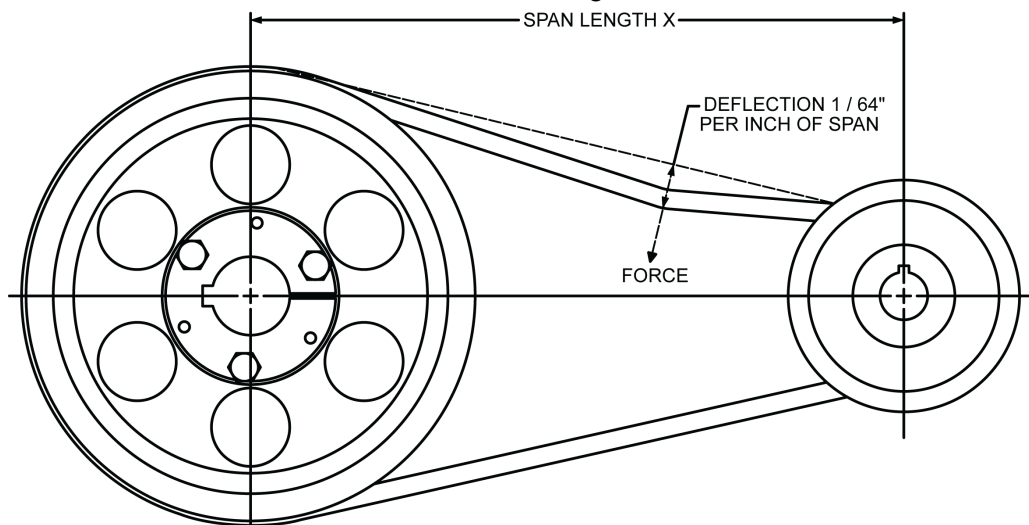

## SHEAVE ALIGNMENT

With the use of a straight edge, sheave alignment can be checked quickly and accurately. One of the sheaves will have to be loose on its shaft in order to make adjustment. Adjust until all 4 points are in contact with the straight edge (see Figure below). Repeat on the other side of sheaves and then re-tighten.

If a face width variation exists, measure the difference between each side of the narrowest sheave and adjust until both sides are an equal distance from the straight edge.

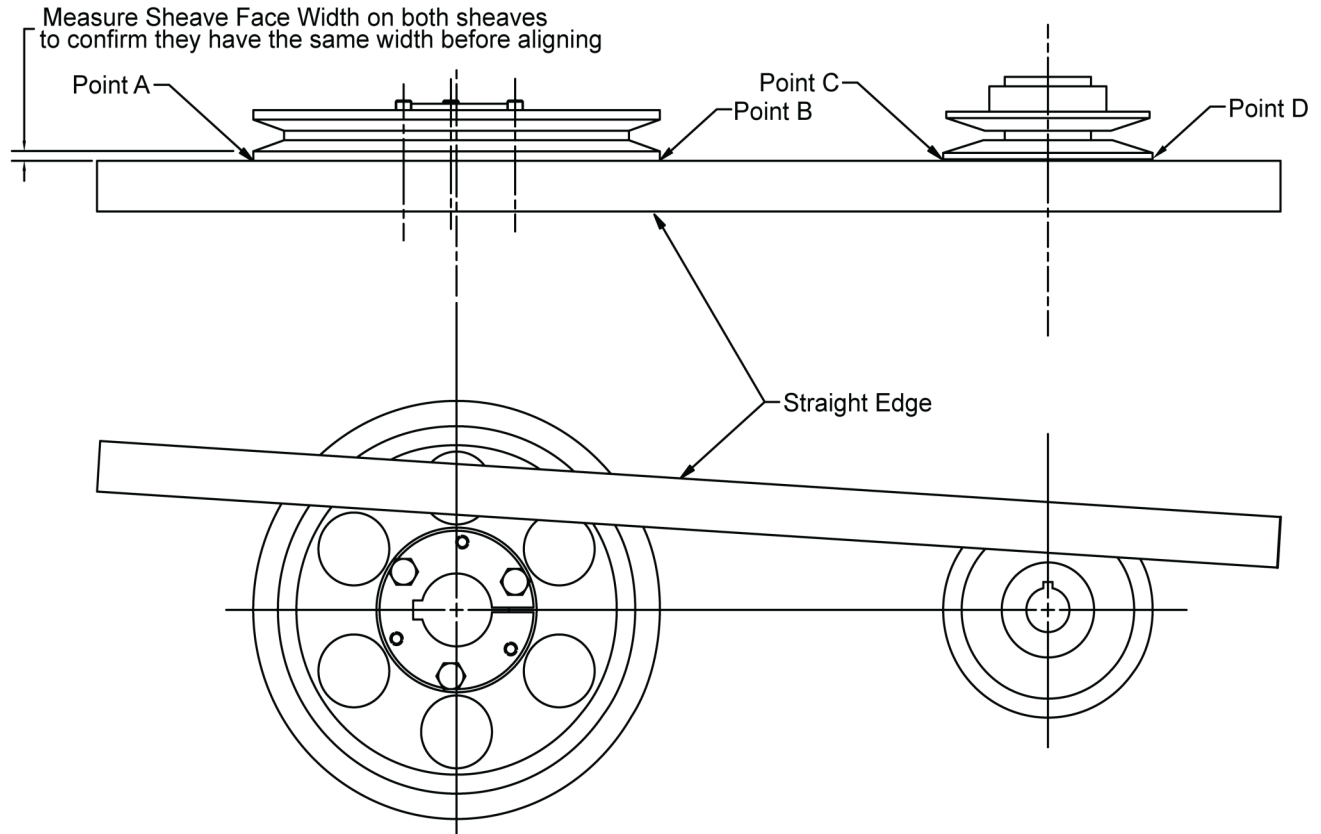

## BELT REPLACEMENT CONSIDERATIONS

**IMPORTANT:** Do not force belts onto sheaves by using a pry bar or by rolling the sheaves.

**NOTICE:** Match the size of the new belts to existing ones, except if the sheave groove size was adjusted. Replace drive belts in complete sets. Purchase set of belts from the same manufacture.



# MAINTENANCE

## BLOWER BEARINGS

Bearings must be checked during each periodic maintenance inspection. Bolts and set screws should be checked for tightness and the bearings may need lubrication. *Refer to website for specific manufacturer cut sheets pertaining to bearing maintenance.*

**Bearing Lubricate:** Any good quality lithium or lithium complex base grease using mineral oil conforming to NLGI grade 2 consistency and an oil viscosity of 455-1135 SUS at 100°F (100-250 cSt at 40°C) may be used for re-lubrication.(Only applicable if unit blower bearings are Browning AH (Air Handler))

IMPORTANT: The following table is intended only as a guide to aid you in setting up your own schedule.

### LUBRICATION GUIDE FOR BLOWER BEARINGS

<b>Operating Conditions</b>	<b>Bearing Temp. (°F)</b>	<b>Grease Interval</b>
<b>Clean</b>	<b>32 – 120</b>	<b>6 – 10 ,months</b>
	<b>120 – 150</b>	<b>1 – 3 months</b>
	<b>150 – 200</b>	<b>1 – 4 weeks</b>
<b>Dirty</b>	<b>32 – 150</b>	<b>1 – 4 weeks</b>
	<b>150 – 200</b>	<b>Daily – 1 week</b>
<b>Moisture</b>	<b>32 - 200</b>	<b>Daily – 1 week</b>

## MOTOR BEARINGS

Motor bearings in a clean environment should be lubricated every 2 to 3 years. Under more severe conditions of dirt or moisture, lubrication may be required every 6 months to 1 year. Refer to website for specific manufacturer cut sheets pertaining to motor bearing maintenance.

Typical motor bearing lubrication procedure follows:

1. Remove fill and drain plugs.
2. Clean drain port of hard grease (with wire if necessary).
3. Add grease (cavity should be no more than ½ full.).
4. Start motor and let run for 10 minutes.
5. Wipe off any drained grease and replace fill and drain plugs.



IMPORTANT: Avoid adding an excessive amount of grease since this a common cause of motor failure.











































































## BLOWER WHEEL

Ensure that blower hub is securely fastened to shaft. Inspect blower wheel and blades for signs of damage or cracks. Clean blades if necessary to maintain proper balance and performance. Avoid use of excessive grease on blower bearings that can coat fan blades and attract dirt.

## FIREYE MICRO M SERIES LED INDICATING LIGHTS – STANDARD OPERATION

- Operating Control - Energized whenever the burner control switch is on and power is applied to terminal #7 in the flame safeguard.
- Interlock - Illuminated solid when power is applied on terminal # 6 in the flame safeguard to indicate that the air flow switch and other control & limit switches are closed. This light flashes once per second if the user has selected the fan-only mode (summer) or if an airflow switch or other safety circuit switch is open.
- PTFI - Illuminated only during the pilot trial for ignition period.
- Flame - Illuminated when flame signal is detected.
- Alarm - LED will flash once per second when an alarm condition is detected.

Symbol Legend					
Flashing Light		Solid Light		Light Off	

Lockout Description	OPR CNTL	INTRLK	PTFI	FLAME	ALARM
Line Frequency Noise Detected					
Flame Fail – PTFI					
Fault Unknown					
Amplifier High Count Fail					
Flame Fail – MTFI					
False Flame – Standby					
Interlock Open					
Interlock Closed					
Chassis Opto					
Flame Fail – Auto					
Check Chassis					
Check Programmer					
Amplifier Auto Check Fail					
Check Blown Fuse					
Check Sensor					



## FIREYE MICRO M SERIES LED INDICATING LIGHTS – ALARM MODE

Line Frequency Noise Detected - At start up, the MICRO M measures the AC line to determine if the input is 50 Hz or 60 Hz and set its flag accordingly. As the system is running, line frequency is constantly monitored. Outside interference causing a momentary shift in line frequency could be from SCR controls, VFD's, etc.

Flame Fail - PTFI - No flame signal present at the end of pilot trial for ignition period.

Fault Unknown - A catch all message when, under certain high noise conditions, the lockout message may become garbled and not translatable into any existing message

Amplifier Count Fail - A message used to detect a failed amplifier module that would generate an inordinate amount of pulses to micro computer, usually due to a shorted transistor or oscillating electronic filter.

Flame Fail - MTFI - No flame signal present during main burner trial for ignition period.

Flame Fail - Standby - Flame signal present, for a constant 60 seconds, while control is in standby or off condition.

Interlock Open - Interlock safety circuit (terminal #6) has been detected open for longer than ten minutes during the purge cycle or during main flame period on MEP 562.

Interlock Closed - If selected by dip switches, air flow or interlock switch (terminal #6) is closed 30 seconds after the start of a cycle or when terminal #7 is closed. Titan Air does not use this function.

Chassis Opto - Opto coupler located on chassis has been found to be defective. Opto couplers are checked every 1/2 cycle of the AC main(s) to ensure they are off during the negative 1/2 cycle.

Flame Fail Auto - If dip switches selected for non-recycle, no flame is detected during the run cycle or main flame period.

Check Chassis - At beginning of cycle terminal #5 is energized.

Check Programmer - At beginning of cycle terminal #3 is energized or an internal diagnostics test for the Micro controller has failed.

Check Amplifier - Diagnostic problem with amplifier has been found.

Amplifier Auto Check - The amplifier is checked every 8 seconds by the micro computer to assure it is responding properly.

Check Blown Fuse - At the end of pilot try for ignition, no flame is detected and no power is present on terminal #3, indicating the fuse, located on chassis, is blown.

Check Scanner - The UV self check scanner (UV equipped units only) is producing flame pulses during the shutter closed period due to a malfunctioning shutter or a run-away UV tube.





## GENERAL START-UP INFORMATION

Even though Titan Air equipment is tested prior to leaving the factory, a complete field start-up is essential for proper operation of the equipment. Qualified individuals should perform installation, start-up and maintenance tasks.

The factory cannot duplicate the conditions the equipment will see in the actual installation (i.e. gas pressure, static pressure, desired control settings, etc...). For this reason there are field adjustments that have to be made. Performing a complete start-up procedure will help ensure that correct adjustments are made and correct operation is verified. A step-by-step start-up procedure is provided on subsequent pages. While working through the start-up procedure, record information on the start-up checklist and return to Titan Air to validate the equipment warranty. The start-up checklist is provided on cardstock with Titan Air's address pre-printed on one side.

Because most component failures occur during start-up, it is very important that the function of every component be checked out during start-up. It is just as important that the start-up technician realize the malfunction of a component may be caused by other factors (i.e. air flow, gas pressure, field wiring, etc...) and should fully investigate a component malfunction and its cause before replacing the component.

Titan Air checks out all returned components and has found approximately 70% of returned parts are in full operational condition. This history has proven that a little extra time invested in troubleshooting will often save the considerable investment in parts, time, and paperwork associated with replacing components.

### SUGGESTED TOOLS AND INSTRUMENTS NEEDED FOR START-UP:

- Volt/Ohm Meter
- Ammeter
- Tachometer (preferably non-contact style)
- Thermometer (preferably digital with remote probes and sufficient lead lengths)
- Gas pressure gauge (-10" to 0 to +10" of water column typical scale)
- Air differential pressure gauge (-2" to 0 to +2" of water column typical scale)
- Standard Hand Tools

Additional items for Maxitrol Series 14 or 44 temperature controls:

- 10,000 Ohm potentiometer
- ½ watt, 10,000 Ohm resistor
- ½ watt, 2,000 Ohm resistor

Additional items for temperature controls using Digital Programmable Controller:

- 1,070 Ohm resistor (supplied)



# VALVE LEAK TEST

## VALVE LEAK TEST

This is a test for checking the closure tightness of the gas safety shutoff valve. It should be performed by trained and experienced technicians. This test should be part of the scheduled inspections and maintenance procedures.

1. Close the upstream manual gas valve.
2. Make sure manual test cock on leak test assembly is closed.
3. Remove the test plug on leaving side of gas valve.
4. Close the downstream manual gas valve.
5. Open the upstream manual gas valve.
6. Through the safety system enable the gas valve momentarily.
7. Immerse a 1/4" tube vertically into a jar of water.
8. Slowly open the test cock on the leak assembly.
9. Once the rate of bubbles through the test assembly stabilizes, count the number of bubbles appearing during the ten second time frame. Each bubble is approximately 0.001 cfh.
10. Do this test for each shut off valve.

Reference below leak test assembly and leakage rate chart.

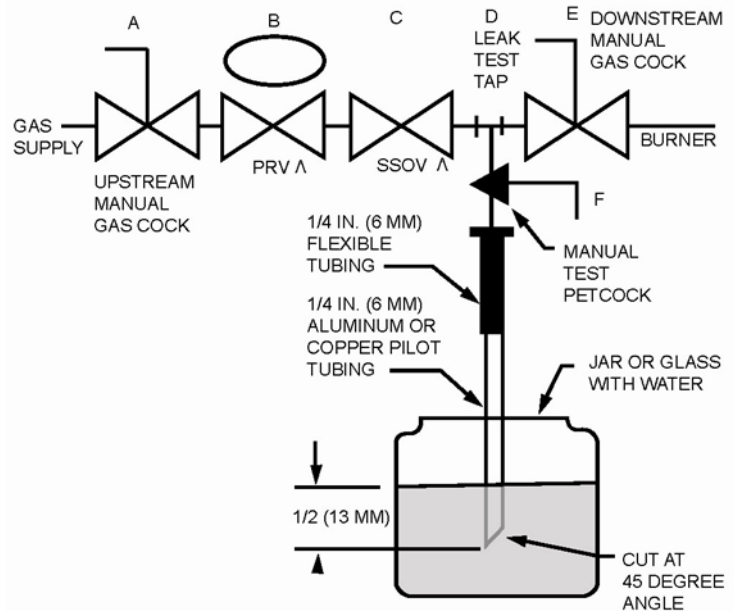

Pipe Size (in)	Medium	Allowable Leakage SCCH	Max. # of Bubbles in 10 Sec.	Min. # of sec. for 10 bubbles
3/8 & 1/2	.64 gas	294	7	13
	1.57 LP	188	4	20.4
3/4 & 1	.64 gas	301	7	12.7
	1.57 LP	192	5	19.9
1-1/4 & 1-1/2	.64 gas	532	13	7.2
	1.57 LP	341	8	11.2
2	.64 gas	578	15	6.6
	1.57 LP	370	9	10.3
1-1/2	.64 gas	752	19	5.1
	1.57 LP	481	12	8
3	.64 gas	925	24	4.1
	1.57 LP	592	15	6.5